

Features of the Boiler Control 265

Please refer to Essay E 005: Control Functions and Benefits for a detailed description of these features.

- Outdoor Reset
- Characterized Heating Curve
- Water Temperature Setback
- Boost
- Warm Weather Shut Down
- Boiler Outdoor Reset
- Soft Stop
- Boiler Differential (Automatic)
- Boiler Minimum Supply
- Boiler Post Purge
- PID Staging
- Equal Run Time Rotation
- Sequential Modulation
- Fixed Lead
- Fixed Last
- Fire Delay
- Boiler Mass
- DHW Boiler Reset Override
- DHW Priority
- DHW Priority Override
- DHW Post Purge
- DHW Mixing Purge
- Setpoint Boiler Reset Override
- Setpoint Priority
- Modulating Output
- Parallel Modulation

Application

The tekmar Boiler Control 265 can control the supply water temperature on up to three modulating boilers based on outdoor temperature or setpoint requirements. The control can be set to control up to two modulating boilers based on outdoor temperature or domestic hot water requirements. The control has outputs for a primary pump, individual boiler pumps, and either a combustion air damper or an alert.

- A1 = Alert
- P1 = Boiler Pump 1
- P2 = Boiler Pump 2
- P3 = Boiler Pump 3
- P4 = System Pump
- S1 = Boiler Supply Sensor 071
- S2 = Boiler Return Sensor 071
- S3 = Outdoor Sensor 070

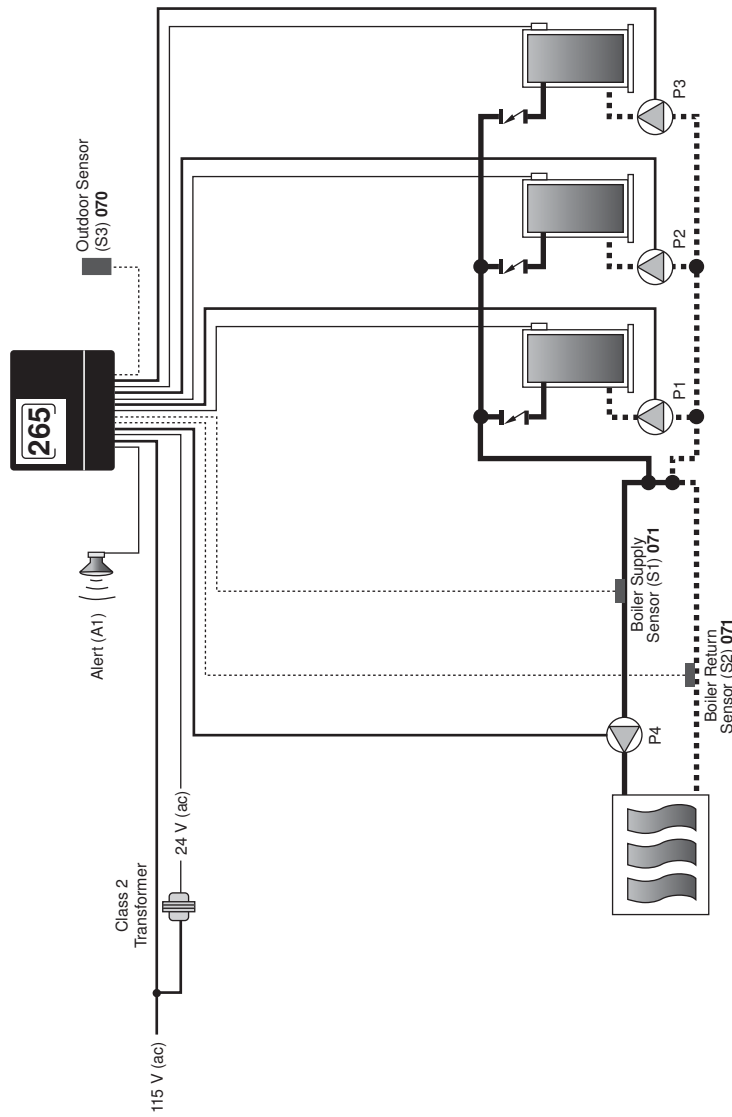

Concept Drawing

This is only a concept drawing, not an engineered drawing. It is not intended to describe a complete system, nor any particular system. It is up to the system designer to determine the necessary components for and configuration of the particular system being designed, including additional equipment, isolation relays (for loads greater than the control's specified output ratings), and any safety devices which in the judgement of the designer are appropriate, in order to properly size, configure and design that system and to ensure compliance with building and safety code requirements.

System Operation

The Boiler Control 265 provides outdoor reset to a space heating system. Line voltage is used to provide a permanent boiler demand. The boilers are piped in primary-secondary and the boiler pumps are controlled by the 265 to allow post purging of the boilers after they have shut off. The control has an alert contact which closes when there is an error message. The Warm Weather Shut Down feature prevents the boilers from firing in the summer months, ensuring the heating space does not overheat.

tekmar Control Systems Ltd., Canada; tekmar Control Systems, Inc., U.S.A.; www.tekmarcontrols.com
Head Office: 5100 Silver Star Road, Vernon, B.C. Canada, V1B 3K4; (250) 545-7749 Fax (250) 545-0650

- A1 = Alert
- P1 = Boiler Pump 1
- P2 = Boiler Pump 2
- P3 = Boiler Pump 3
- P4 = System Pump
- S1 = Boiler Supply Sensor 071
- S2 = Boiler Return Sensor 071
- S3 = Outdoor Sensor 070

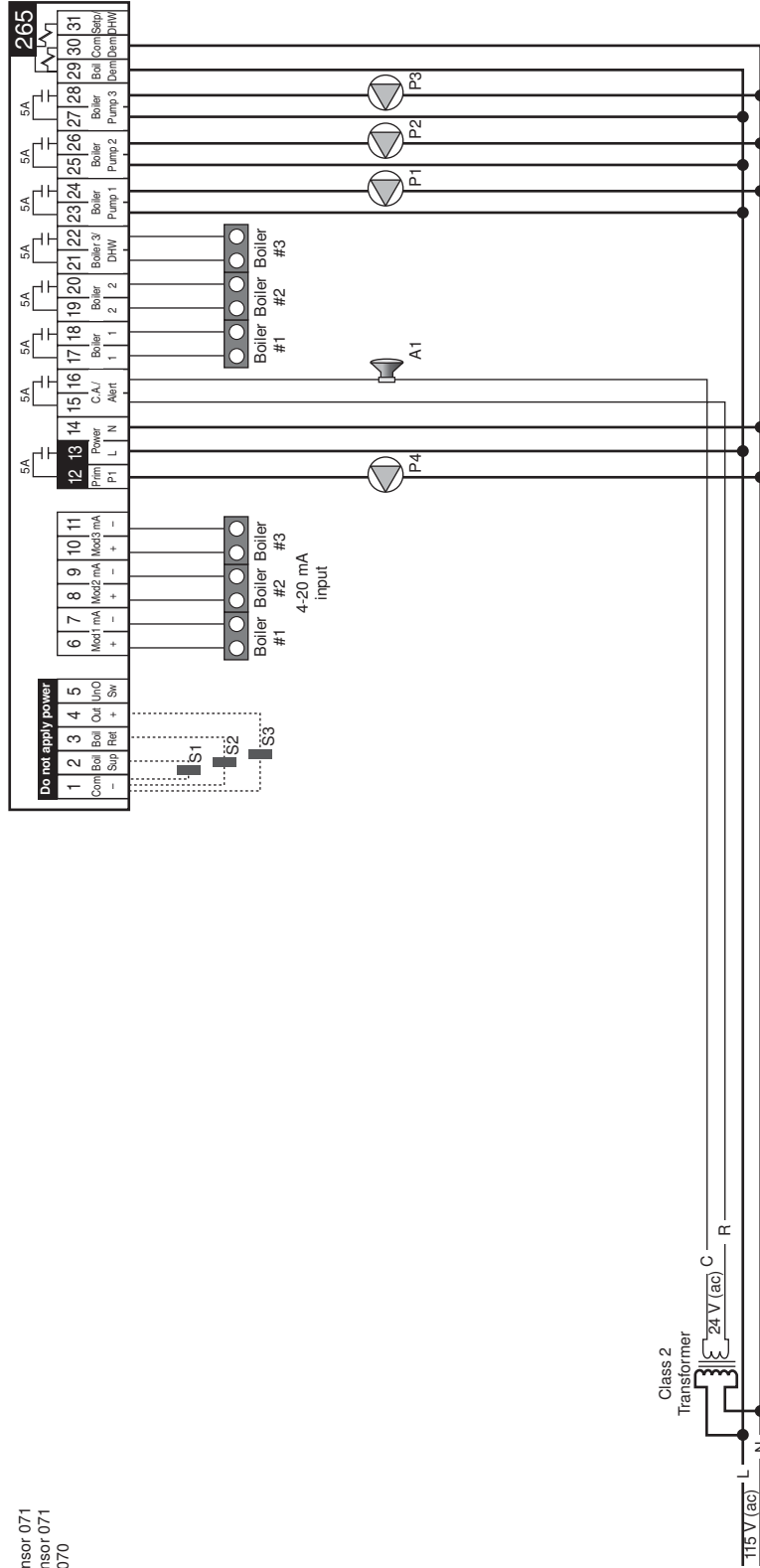

Concept Drawing

This is only a concept drawing, not an engineered drawing. It is not intended to describe a complete system, nor any particular system. It is up to the system designer to determine the necessary components for and configuration of the particular system being designed, including additional equipment, isolation relays (for loads greater than the control's specified output ratings), and any safety devices which in the judgement of the designer are appropriate, in order to properly size, configure and design that system and to ensure compliance with building and safety code requirements.

Essential Control Settings

Boil 3 ≠ OFF



- C1 = Combustion Air Damper
- P1 = Boiler Pump 1
- P2 = Boiler Pump 2
- P3 = Boiler Pump 3
- P4 = System Pump
- P5 = Setpoint Temperature Pump
- S1 = Boiler Supply Sensor 071
- S2 = Boiler Return Sensor 071
- S3 = Outdoor Sensor 070
- S4 = Setpoint Sensor 071
- R1 = Relay 003
- V1 = Pressure Differential Bypass Valve
- Z1, Z2 = Zone Valves

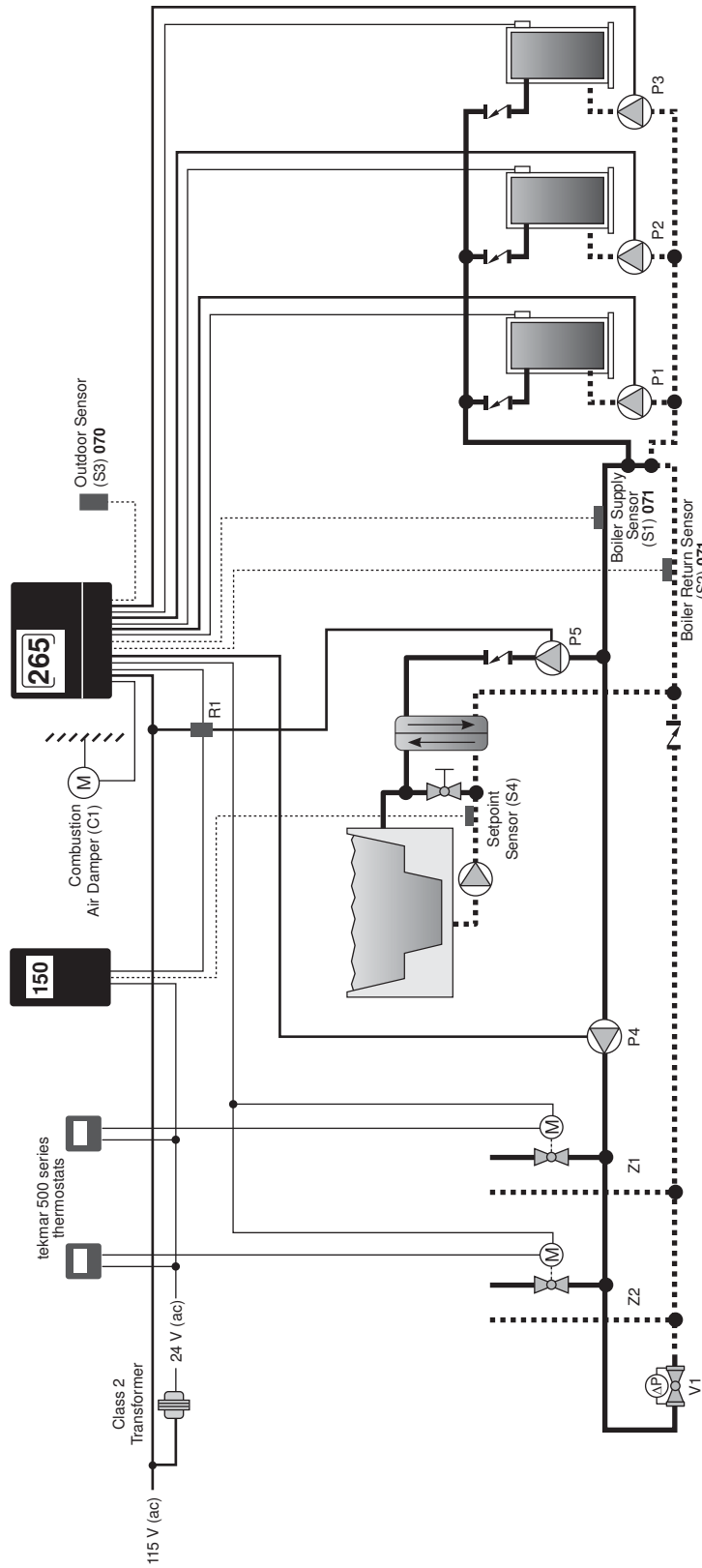

Concept Drawing

This is only a concept drawing, not an engineered drawing. It is not intended to describe a complete system, nor any particular system. It is up to the system designer to determine the necessary components for and configuration of the particular system being designed, including additional equipment, isolation relays (for loads greater than the control's specified output ratings), and any safety devices which in the judgement of the designer are appropriate, in order to properly size, configure and design that system and to ensure compliance with building and safety code requirements.

System Operation

The Boiler Control 265 provides outdoor reset to a space heating system and a setpoint load. The 265 provides modulation to three modulating boilers. The boilers are piped in primary-secondary and the boiler pumps are controlled by the 265 to allow for post purging of the boilers after they have shut off. A combustion air damper is also controlled by the 265.

tekmar Control Systems Ltd., Canada: tekmar Control Systems, Inc., U.S.A.: www.tekmarcontrols.com
 Head Office: 5100 Silver Star Road, Vernon, B.C. Canada, V1B 3K4; (250) 545-7749 Fax (250) 545-0650

- C1 = Combustion Air Damper
- P1 = Boiler Pump 1
- P2 = Boiler Pump 2
- P3 = Boiler Pump 3
- P4 = System Pump
- P5 = Setpoint Temperature Pump
- S1 = Boiler Supply Sensor 071
- S2 = Boiler Return Sensor 071
- S3 = Outdoor Sensor 070
- S4 = Setpoint Sensor 071
- R1 = Relay 003
- Z1, Z2 = Zone Valves

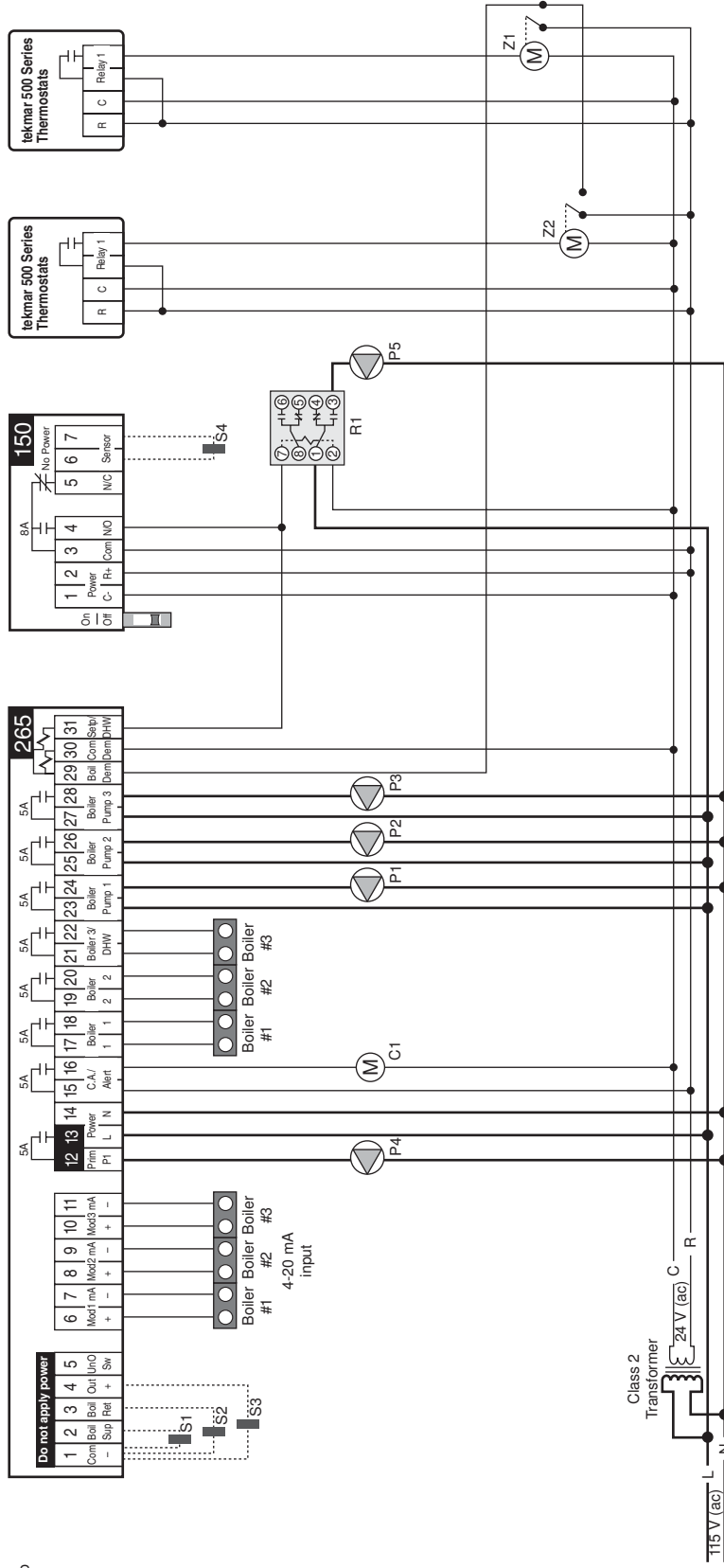

Concept Drawing

This is only a concept drawing, not an engineered drawing. It is not intended to describe a complete system, nor any particular system. It is up to the system designer to determine the necessary components for and configuration of the particular system being designed, including additional equipment, isolation safety devices greater than the control's specified output ratings), and any safety devices which in the judgement of the designer are appropriate, in order to properly size, configure and design that system and to ensure compliance with building and safety code requirements.

Essential Control Settings

DHW MODE = OFF
Setpoint MODE = 1 (no priority)
2 (priority)

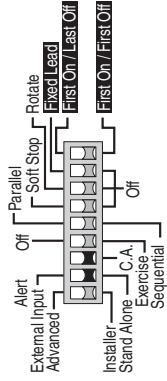

required

optional

- A1 = Alert
- P1 = Boiler Pump 1
- P2 = Boiler Pump 2
- P3 = Boiler Pump 3
- P4 = System Pump
- S1 = Boiler Supply Sensor 071
- S2 = Boiler Return Sensor 071

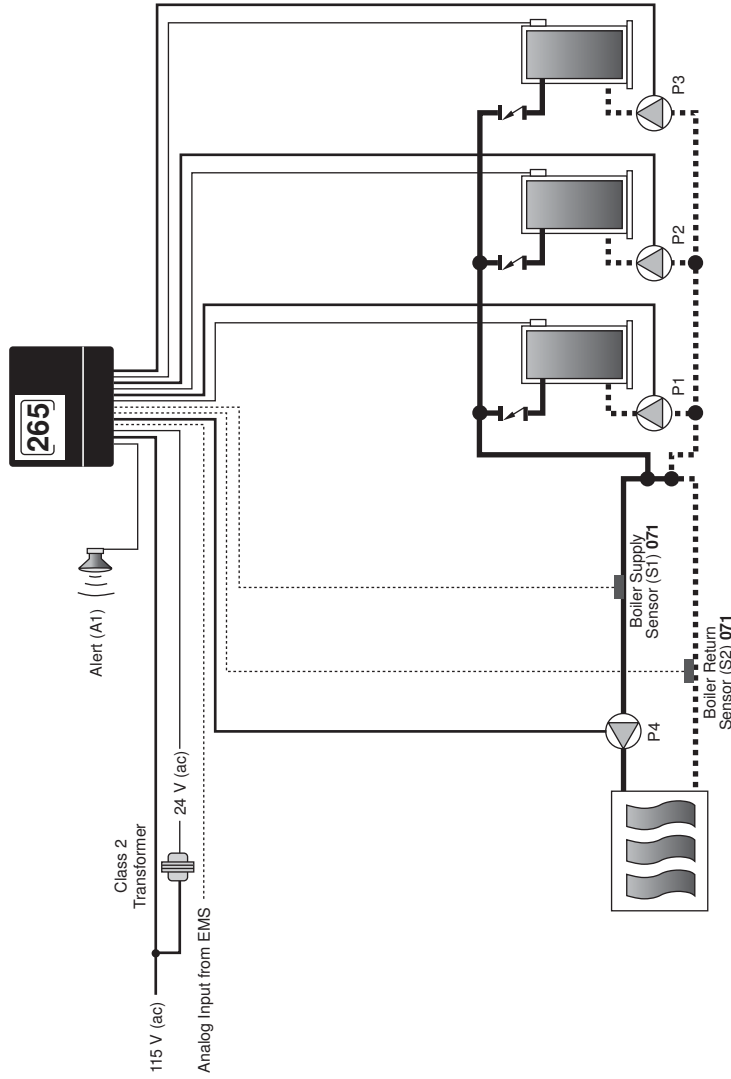

Concept Drawing

This is only a concept drawing, not an engineered drawing. It is not intended to describe a complete system, nor any particular system. It is up to the system designer to determine the necessary components for and configuration of the particular system being designed, including additional equipment, isolation relays (for loads greater than the control's specified output ratings), and any safety devices which in the judgement of the designer are appropriate, in order to properly size, configure and design that system and to ensure compliance with building and safety code requirements.

System Operation

An Energy Management (EMS) provides the Boiler Control 265 the Boiler Target temperature using a 0 to 10 V (dc) or 2 to 10 V (dc) signal. The boilers are piped in primary-secondary and the boiler pumps are controlled by the 265 to allow post purging of the boilers after they have shut off. The 265 has an alert contact which closes when there is an error message.

tekmar Control Systems Ltd., Canada: tekmar Control Systems, Inc., U.S.A.: www.tekmarcontrols.com
Head Office: 5100 Silver Star Road, Vernon, B.C. Canada, V1B 3K4; (250) 545-7749 Fax (250) 545-0650

- A1 = Alert
- P1 = Boiler Pump 1
- P2 = Boiler Pump 2
- P3 = Boiler Pump 3
- P4 = System Pump
- S1 = Boiler Supply Sensor 071
- S2 = Boiler Return Sensor 071

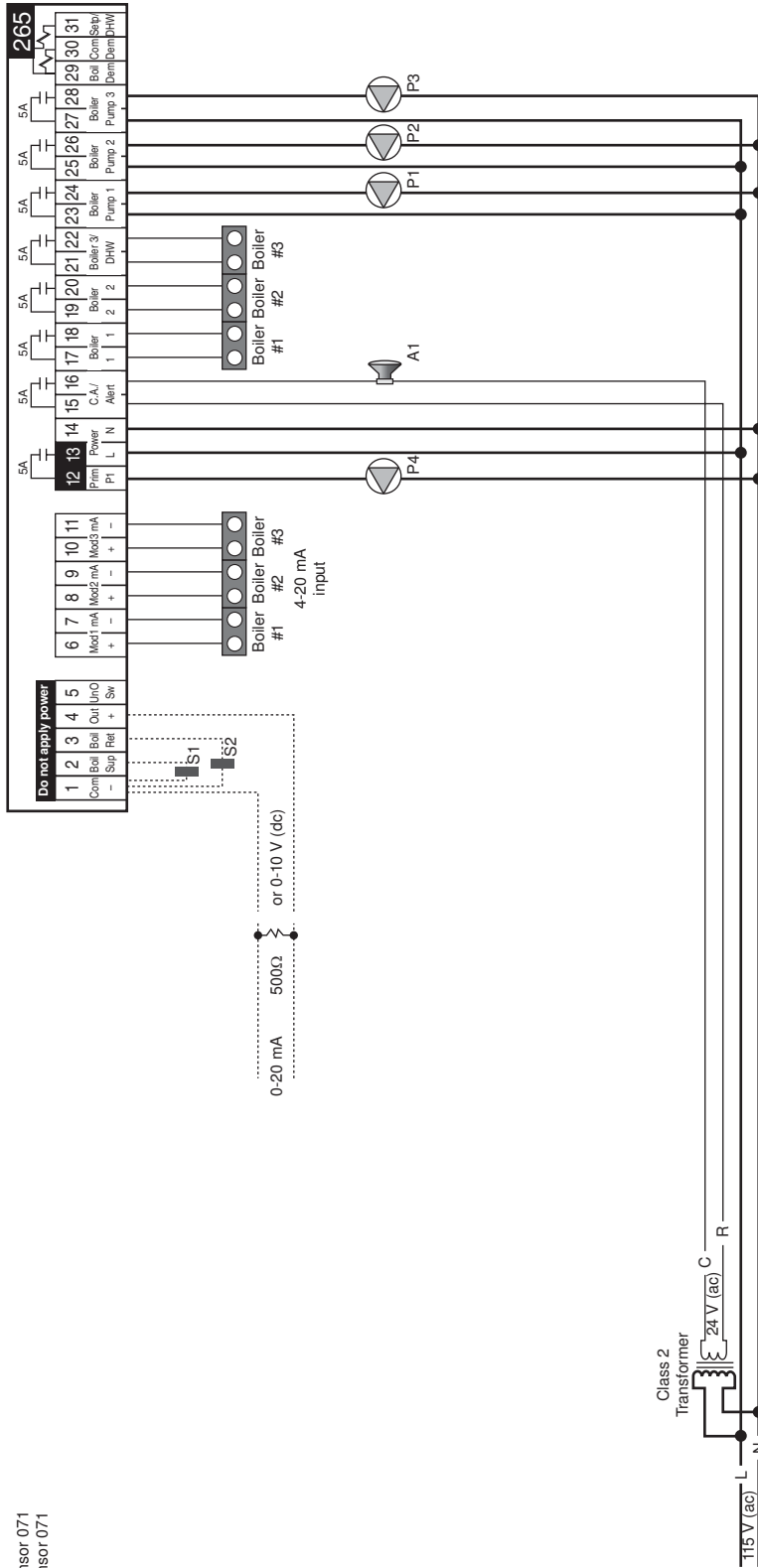

Concept Drawing

This is only a concept drawing, not an engineered drawing. It is not intended to describe a complete system, nor any particular system. It is up to the system designer to determine the necessary components for and configuration of the particular system being designed, including additional equipment, isolation relays (for loads greater than the control's specified output ratings), and any safety devices which in the judgement of the designer are appropriate, in order to properly size, configure and design that system and to ensure compliance with building and safety code requirements.

Essential Control Settings



- required
- optional

tekmar Control Systems Ltd., Canada; tekmar Control Systems, Inc., U.S.A.; www.tekmarcontrols.com
Head Office: 5100 Silver Star Road, Vernon, B.C. Canada, V1B 3K4; (250) 545-7749 Fax (250) 545-0650

- A1 = Aquastat
- C1 = Combustion Air Damper
- P1 = Boiler Pump 1
- P2 = Boiler Pump 2
- P3 = System Pump
- P4 = DHW Pump
- S1 = Boiler Supply Sensor 071
- S2 = Boiler Return Sensor 071
- S3 = Outdoor Sensor 070
- Z1, Z2 = Zone Valves

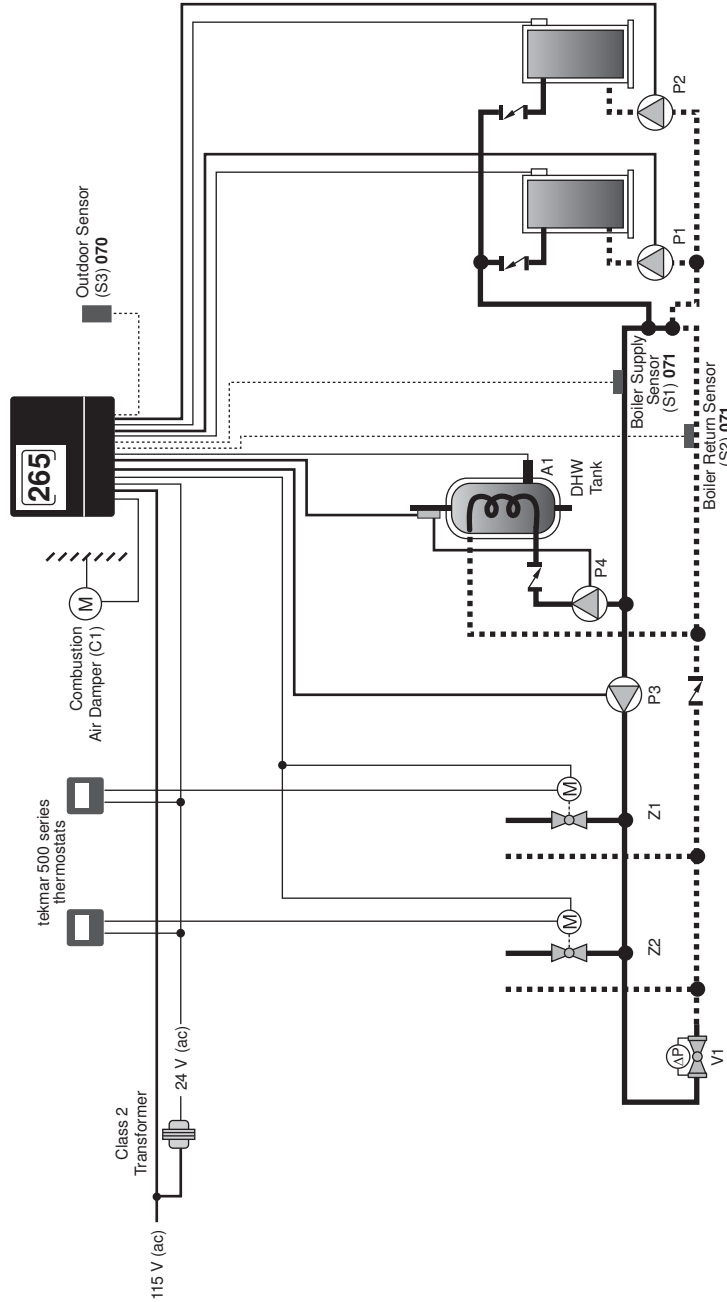

Concept Drawing

This is only a concept drawing, not an engineered drawing. It is not intended to describe a complete system, nor any particular system. It is up to the system designer to determine the necessary components for and configuration of the particular system being designed, including additional equipment, isolation relays (for loads greater than the control's specified output ratings), and any safety devices which in the judgement of the designer are appropriate, in order to properly size, configure and design that system and to ensure compliance with building and safety code requirements.

System Operation

The Boiler Control 265 provides outdoor reset to a space heating system and domestic hot water load. The 265 provides modulation to two modulating boilers. The boilers are piped in primary-secondary and the boiler pumps are controlled by the 265 to allow for post purging of the boilers after they have shut off. A combustion air damper is also controlled by the 265.

tekmar Control Systems Ltd., Canada; tekmar Control Systems, Inc., U.S.A.; www.tekmarcontrols.com
Head Office: 5100 Silver Star Road, Vernon, B.C. Canada, V1B 3K4; (250) 545-7749 Fax (250) 545-0650

- A1 = Aquastat
- C1 = Combustion Air Damper
- P1 = Boiler Pump 1
- P2 = Boiler Pump 2
- P3 = System Pump
- P4 = DHW Pump
- S1 = Boiler Supply Sensor 071
- S2 = Boiler Return Sensor 071
- S3 = Outdoor Sensor 070
- V1 = Pressure Differential Bypass Valve
- Z1, Z2 = Zone Valves

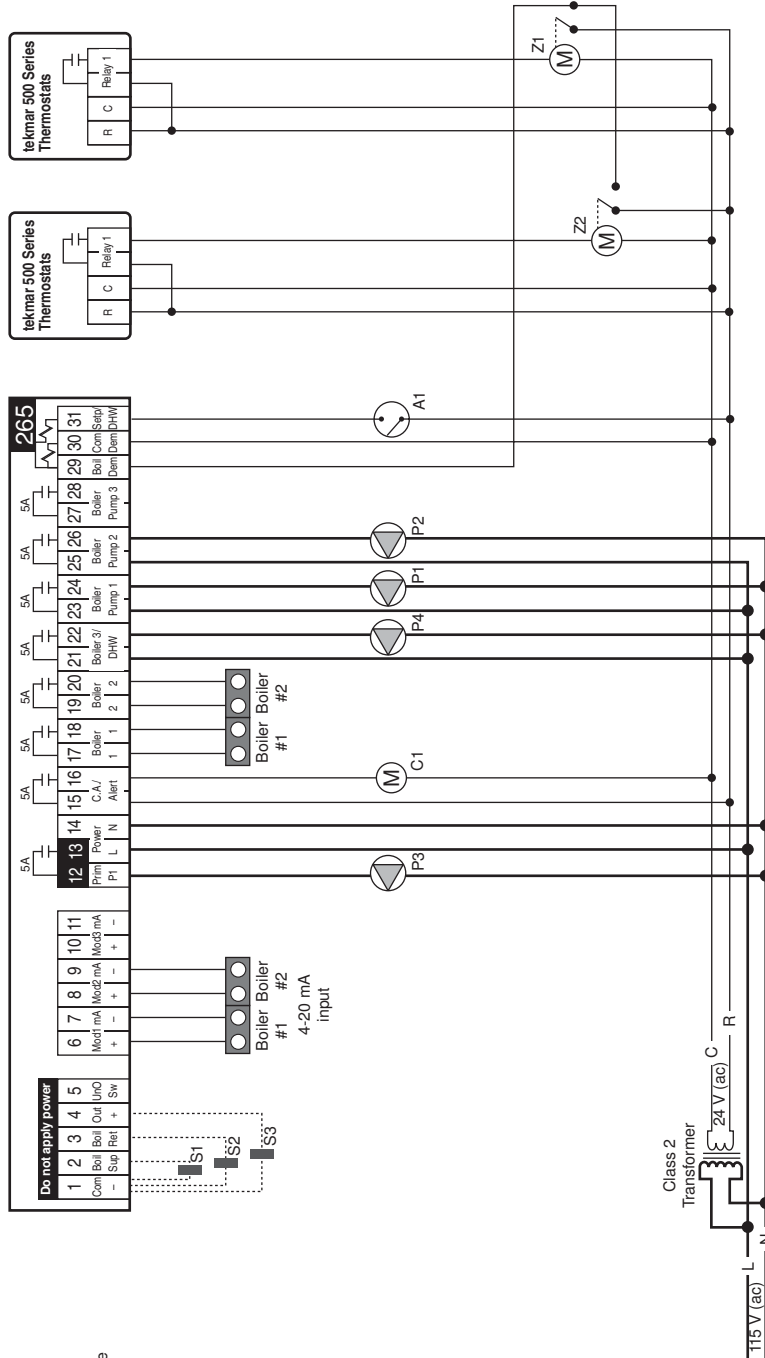

Concept Drawing

This is only a concept drawing, not an engineered drawing. It is not intended to describe a complete system, nor any particular system. It is up to the system designer to determine the necessary components for and configuration of the particular system being designed, including additional equipment, isolation relays (for loads greater than the control's specified output ratings), and any safety devices which in the judgement of the designer are appropriate, in order to properly size, configure and design that system and to ensure compliance with building and safety code requirements.

Essential Control Settings

- Boil 3 = OFF
- DHW MODE = 1 (no priority)
- 2 (priority)

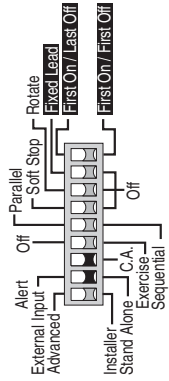

required

optional

- A1 = Aquastat
- C1 = Combustion Air Damper
- P1 = Boiler Pump 1
- P2 = Boiler Pump 2
- P3 = System Pump
- P4 = DHW Pump
- P5, P6 = Zone Pumps
- R1 = Relay 004
- R2, R3 = Relay 003
- S1 = Boiler Supply Sensor 071
- S2 = Boiler Return Sensor 071
- S3 = Outdoor Sensor 070

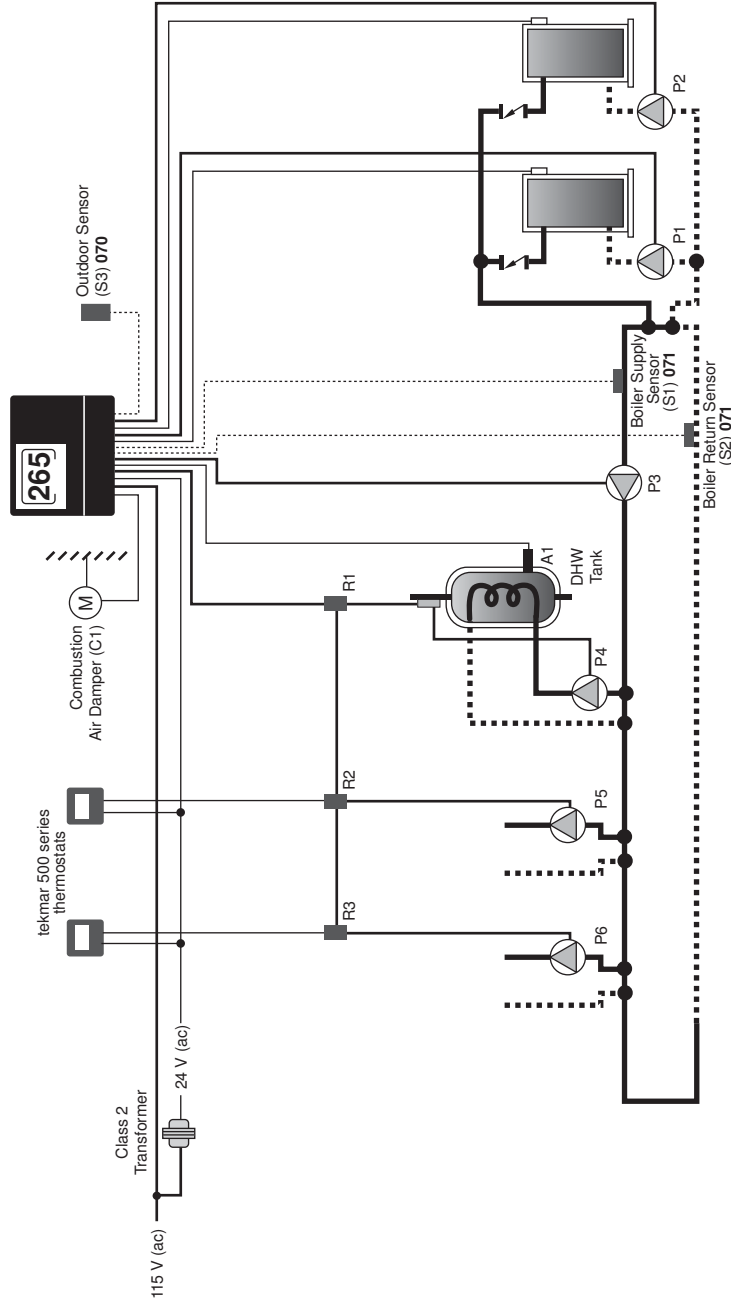

Concept Drawing

This is only a concept drawing, not an engineered drawing. It is not intended to describe a complete system, nor any particular system. It is up to the system designer to determine the necessary components for and configuration of the particular system being designed, including additional equipment, isolation relays (for loads greater than the control's specified output ratings), and any safety devices which in the judgement of the designer are appropriate, in order to properly size, configure and design that system and to ensure compliance with building and safety code requirements.

System Operation

The Boiler Control 265 provides outdoor reset to a space heating system and domestic hot water load with all zones piped in primary-secondary. The 265 provides modulation to two modulating boilers. The boilers are piped in primary-secondary and the boiler pumps are controlled by the 265 to allow for post purging of the boilers after they have shut off. A combustion air damper is also controlled by the 265. The domestic hot water tank is piped in primary-secondary and has an external relay to provide priority over the space heating.

tekmar Control Systems Ltd., Canada: tekmar Control Systems, Inc., U.S.A.: www.tekmarcontrols.com
Head Office: 5100 Silver Star Road, Vernon, B.C. Canada, V1B 3K4; (250) 545-7749 Fax (250) 545-0650

- A1 = Aquastat
- C1 = Combustion Air Damper
- P1 = Boiler Pump 1
- P2 = Boiler Pump 2
- P3 = System Pump
- P4 = DHW Pump
- P5, P6 = Zone Pumps
- R1 = Relay 004
- R2, R3 = Relay 003
- S1 = Boiler Supply Sensor 071
- S2 = Boiler Return Sensor 071
- S3 = Outdoor Sensor 070

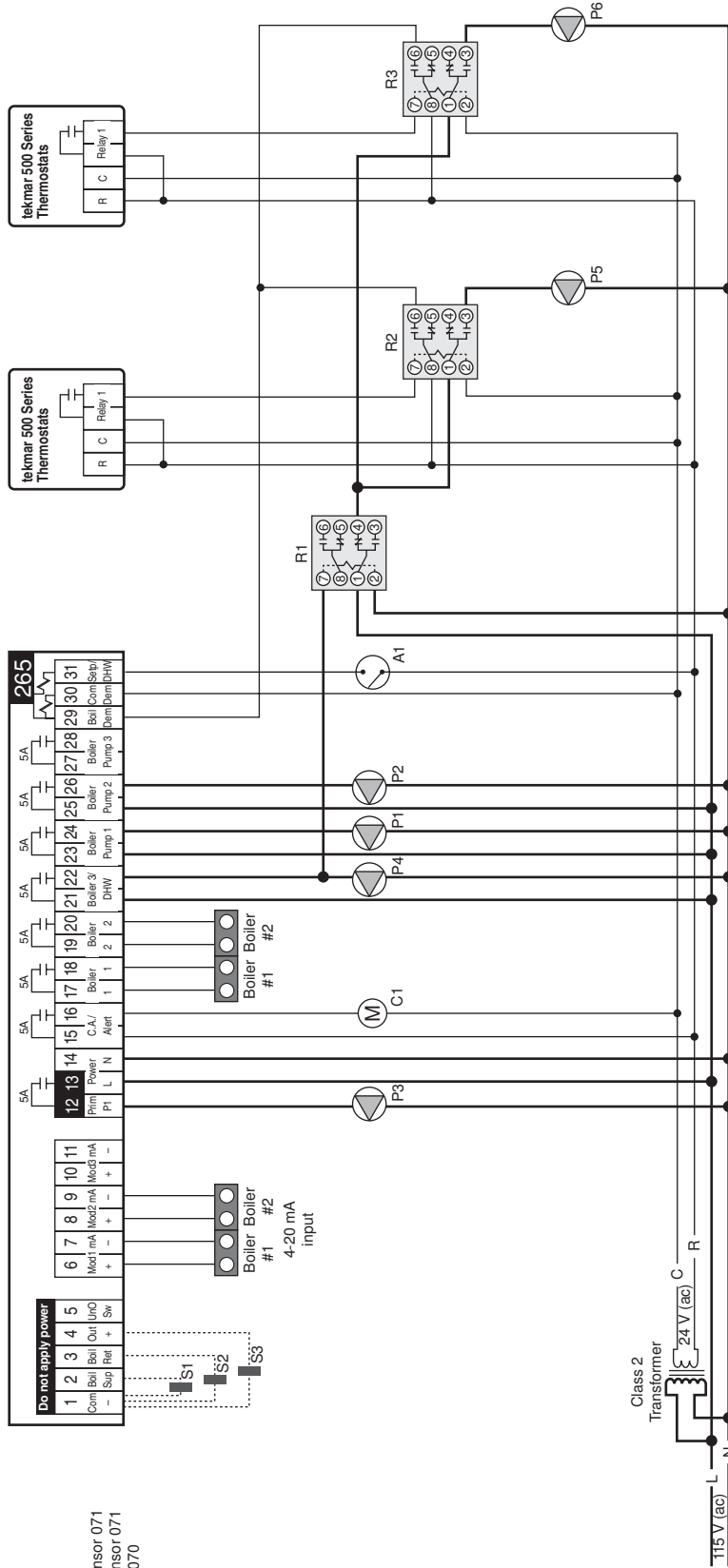

Concept Drawing

This is only a concept drawing, not an engineered drawing. It is not intended to describe a complete system, nor any particular system. It is up to the system designer to determine the necessary components for and configuration of the particular system being designed, including additional equipment, isolation safety devices which in the judgement of the designer are appropriate, in order to properly size, configure and design that system and to ensure compliance with building and safety code requirements.

Essential Control Settings

Boil 3 = OFF
DHW MODE = 4

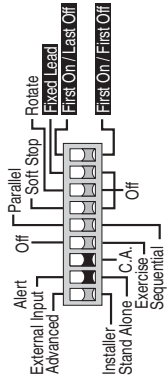

required

optional

Specifications

The following are the recommended specifications for the Boiler Control 265

- The control shall be able to operate one, two, or three modulating boilers.
- The control shall be able to operate one or two boilers during a call for domestic hot water heating.
- The control shall have the ability to calculate the boilers' target temperature based on outdoor reset.
- The control shall have the ability to have the boilers' target temperature set using an adjustable setpoint.
- The control shall have an adjustable warm weather shut down. The warm weather shut down only applies to outdoor reset operation.
- The control shall have a primary pump contact that operates during a call for space heating.
- The control shall have the ability to operate a domestic hot water contact that operates during a domestic hot water call.
- The control shall have the ability to display the current temperature difference between the return temperature and the supply temperature, ΔT .
- The control shall have an option to rotate the firing sequence of the boilers and the option for rotating the boiler firing sequence shall be based on the boilers' accumulated running hours.
- The control shall use proportional, integral and derivative (PID) logic when modulating the boilers.
- The control shall have the option to modulate the boilers in sequential order.
- The control shall have the option to modulate the boilers in parallel.
- The control shall have an adjustable Minimum Supply water temperature setting to help prevent condensation of flue gases and subsequent corrosion and blockage of the boiler's heat exchanger and chimney.
- The control shall have the option of an automatic differential calculation in order to prevent short cycling of the boilers.
- The control shall have the ability to operate a primary pump plus individual boiler pumps.
- The boiler pumps shall have an adjustable post purge setting that allows the pump to run for a set period after the boiler has been shut off.
- The control shall have the option for a fixed lead rotation and when this option is selected, the control shall have an option for either a first on / first off, or first on / last off modulating sequence.
- The control shall have the option for either an alert output or a combustion air damper output. If the combustion air damper is selected, the control shall have an adjustable combustion air damper opening time.
- The control shall have an adjustable minimum inter-stage delay that can be set manually or calculated automatically by the control.
- The control shall have the option of accepting a 0 – 10 V(dc) input signal from an energy management system.
- When operating with a 0 – 10 V(dc) signal, the control shall have an adjustable offset as well as an adjustable input range.
- The control shall have two separate lockable access levels to limit the number of setting adjustments available to various users.
- The control shall have a test button that activates a pre-programmed test sequence testing all the control's outputs.
- The control shall have the ability to show the current outdoor, boiler supply, and boiler return temperatures.
- The control shall continually monitor the temperature sensors and provide an error message upon a control or sensor failure.
- The control shall record and display the running hours of each boiler.
- During extended periods of inactivity, the pumps or valves that are operated by the control shall be periodically exercised to prevent seizure during long idle periods.
- The control shall have the option to gradually modulate the boilers down to low fire before the boilers are shut off.
- The control shall have three 4 – 20 mA or 0 – 20 mA modulating external outputs.
- The control shall have the field upgradable option of converting the modulating output to 0 – 10 V(dc), 2 – 10 V(dc) and 0 - 135 Ω .



tekmar Control Systems Ltd., Canada
tekmar Control Systems, Inc., U.S.A.
Head Office: 5100 Silver Star Road
Vernon, B.C. Canada V1B 3K4
(250) 545-7749 Fax. (250) 545-0650
Web Site: www.tekmarcontrols.com